

Powered by



HR 1221W ▶ 12V 21W

HR 1221W is specially designed for high efficient discharge application. Its characteristics are high energy density, small footprint and high discharge efficiency. It can be used for more than 260 cycles at 100% discharge in cycle service, up to 5 years in standby service.



MH14533(N)



ISO9001
No.:041005117



ISO 14001
NO.UM 1-12-0045

CSB-manufactured VRLA batteries are UL-recognized components under UL924 and UL1989.

CSB is also certified by ISO9001 and ISO14001.

Specification

Cells Per Unit	6
Voltage Per Unit	12
Capacity	21W @15min-rate to 1.67V per cell @25 °C (77°F)
Weight	Approx. 1.80 kg (3.97 lbs)
Maximum Discharge Current	60A/90A (5sec)
Internal Resistance	Approx. 25 mΩ
Operating Temperature Range	Discharge: -15 °C ~ 50 °C (5 °F ~ 122 °F) Charge: -15 °C ~ 40 °C (5 °F ~ 104 °F) Storage: -15 °C ~ 40 °C (5 °F ~ 104 °F)
Nominal Operating Temperature Range	25 °C ± 3 °C (77 °F ± 5 °F)
Float Charging Voltage	13.5 to 13.8 VDC/unit Average at 25 °C (77 °F)
Recommended Maximum Charging Current Limit	2.1A
Equalization and Cycle Service	14.4 to 15.0 VDC/unit Average at 25 °C (77 °F)
Self Discharge	CSB Batteries can be stored for more than 6 months at 25 °C (77 °F). Please charge batteries before using. For high temperatures the time interval will be shorter.
Terminal	F1/F2-Faston Tab 187/250
Container Material	ABS (UL 94-HB/File E50263)* Flammability resistance of (UL 94-V0/File E88637) can be available upon request.

Dimensions :

Unit: mm (inch)

Overall Height (H)	Container height (h)	Length (L)	Width (W)
106.0±1.5 (4.17±0.06)	101.8±1.5 (4.01±0.06)	90.0±1.0 (3.54±0.04)	70.0±1.0 (2.76±0.04)

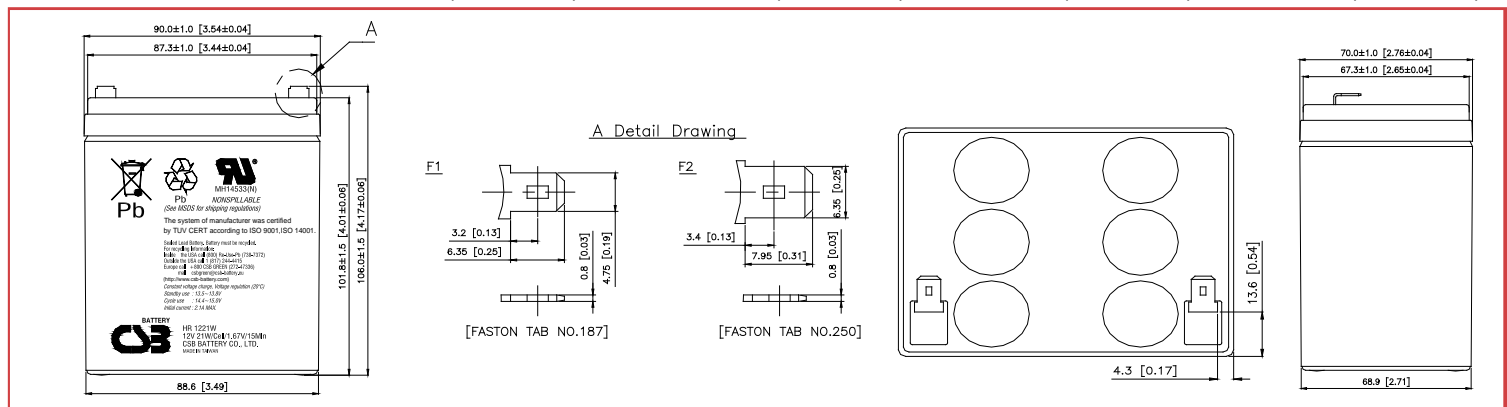

Constant Current Discharge Characteristics Unit:A (25 °C , 77 °F)

F.V/Time	2MIN	4MIN	6MIN	8MIN	10MIN	15MIN	20MIN	30MIN	60MIN	90MIN
1.60V	46.4	31.2	24.4	20.3	17.4	12.9	10.4	7.29	4.02	2.83
1.67V	43.1	29.7	23.6	19.9	17.1	12.5	10.1	7.18	4.00	2.71
1.70V	41.3	28.9	23.2	19.7	16.8	12.3	9.93	7.14	3.99	2.65
1.75V	37.4	27.4	22.2	19.0	16.3	12.1	9.70	7.07	3.98	2.56
1.80V	33.1	25.2	21.0	18.2	15.7	11.8	9.51	7.00	3.96	2.46
1.85V	28.6	22.8	19.2	16.9	14.8	11.5	9.29	6.92	3.95	2.36

Constant Power Discharge Characteristics Unit:W (25 °C , 77 °F)

F.V/Time	2MIN	4MIN	6MIN	8MIN	10MIN	15MIN	20MIN	30MIN	60MIN	90MIN
1.60V	557	374	293	244	209	154	123	87.5	48.2	33.9
1.67V	515	357	284	238	203	150	120	86.6	48.1	32.5
1.70V	495	348	279	234	200	149	119	86.2	48.0	31.9
1.75V	451	329	266	226	194	145	116	85.8	47.9	30.7
1.80V	397	302	250	216	188	141	113	85.4	47.8	29.5
1.85V	343	275	237	208	181	138	111	85.3	47.7	28.3

Trickle (or Float) Service Life

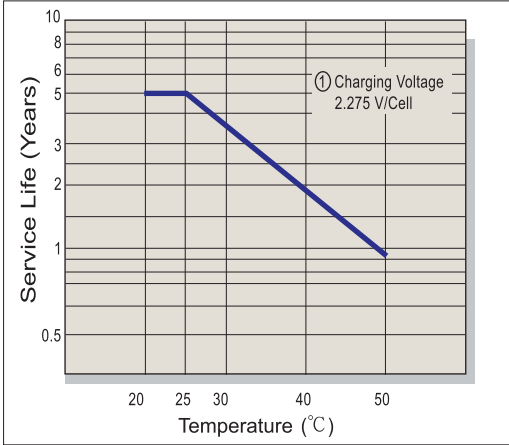

Capacity Retention Characteristic

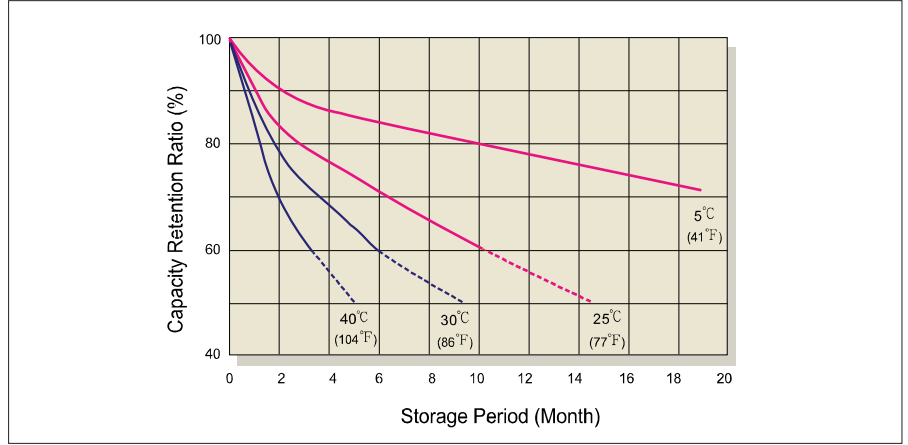

Battery Voltage and Charge Time for Standby Use

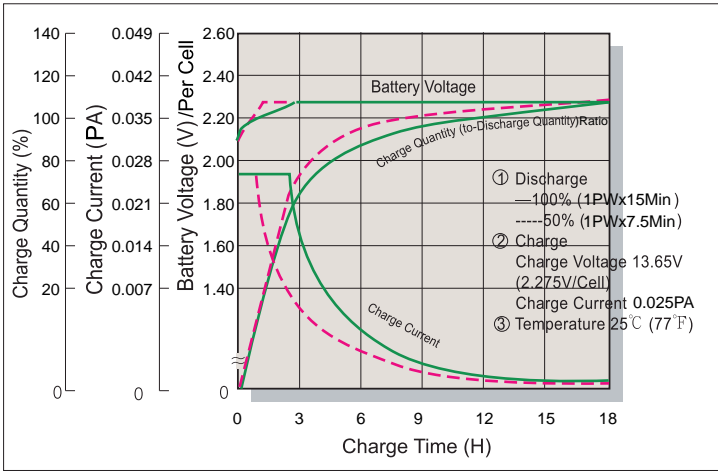

Cycle Service Life

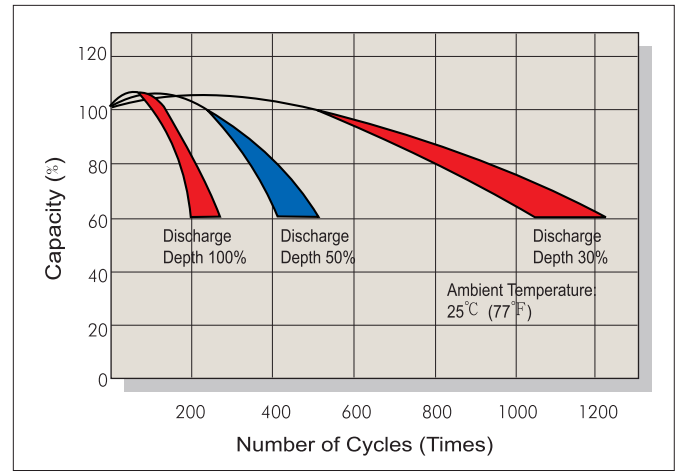

Battery Voltage and Charge Time for Cycle Use

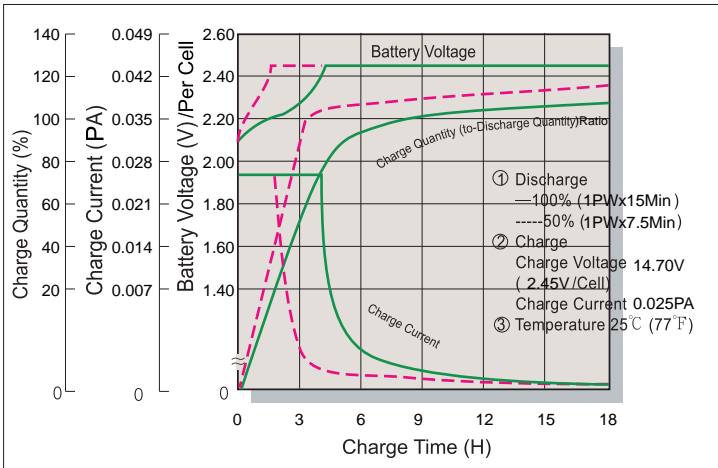

Terminal Voltage (V) and Discharge Time

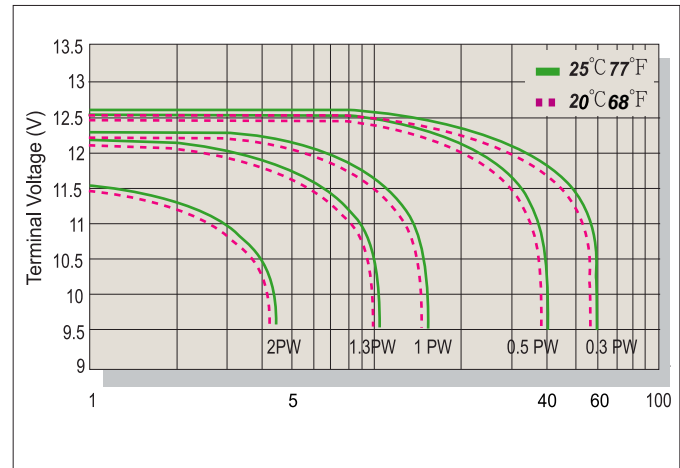

Charging Procedures

Application	Charge Voltage (V/Cell)			Max. Charge Current
	Temperature	Set Point	Allowable Range	
Cycle Use	25°C (77°F)	2.45	2.40~2.50	0.1PA
Standby	25°C (77°F)	2.275	2.25~2.30	

Discharge Current VS. Discharge Voltage

Final Discharge Voltage (V/Cell)	1.75	1.70	1.60	1.30
Discharge Power (W)	0.1P > (W)	0.1P ≤ (W) < 0.25P	0.25P ≤ (W) < 1.0P	(W) ≥ 1.0P

Sales Office URL: WWW.CSB-BATTERY.COM

GLOBAL HQ
 CSB BATTERY CO., LTD. (TAIWAN)
 Tel : +886-2-2880-5600
 Fax : +886-2-2888-3300
 mail : service@csb-battery.com.tw

BEIJING OFFICE. (CHINA)
 CSB BATTERY TECHNOLOGIES (BEIJING) CO., LTD.
 Tel : +86-10-5820-5336/5338
 Fax : +86-10-58203053
 mail : chinasl@csb-battery.com

AMERICA HQ
 CSB BATTERY TECHNOLOGIES INC. (U.S.A)
 Tel : +1-817-244-7777/1-(800)3-CSB-USA(272872)
 Fax : +1-817-244-4445
 mail : csb@csb-battery.com

SHANGHAI OFFICE. (CHINA)
 CSB BATTERY LOGISTIC (SHANGHAI) CO., LTD.
 Tel : +86-21-5046-1622/5046-0833
 Fax : +86-21-5064-3314
 mail : chinasl@csb-battery.com

EUROPE HQ
 CSB Battery Europe BV.
 Tel : +31(0)-180-418-140
 Fax : +31(0)-180-418-327
 mail : eurosales@csb-battery.eu

SHENZHEN OFFICE. (CHINA)
 CSB BATTERY LOGISTIC (SHANGHAI) CO., LTD.
 Tel : +86-755-8831-6488/6396/6356
 Fax : +86-755-8831-6548
 mail : she@csb-battery.com.cn