

GP 12340

12V 34.0Ah

GP 12340 is a general purpose battery with 3-5 years in standby service or more than 260 cycles at 100% discharge in cycle service. As with all CSB batteries, all are rechargeable, highly efficient, leak proof and maintenance free.



Specification

Cells Per Unit	6
Voltage Per Unit	12
Capacity	34Ah @ 20hr-rate to 1.75V per cell @25 °C (77°F)
Weight	Approx. 12.6kg(27.8 lbs)
Maximum Discharge Current	400A(5sec)
Internal Resistance	Approx. 9mΩ
Operating Temperature Range	Discharge: -20°C~50°C (-4°F~122°F) Charge: 0°C~40°C (32°F~104°F) Storage: -20°C~40°C (-4°F~104°F)
Nominal Operating Temperature Range	25°C±3°C (77°F±5°F)
Float Charging Voltage	13.5 to 13.8 VDC/unit Average at 25°C (77°F)
Recommended Maximum Charging Current Limit	10.2A
Equalization and Cycle Service	14.4 to 15.0 VDC/unit Average at 25°C (77°F)
Self Discharge	CSB Batteries can be stored for more than 6 months at 25°C (77°F). Please charge batteries before using. For higher temperatures the time interval will be shorter.
Terminal	Bolt & Nut
Container Material	-ABS (UL94-HB)*Flammability resistance of UL94-V2 can be available upon request.



CSB-manufactured batteries are UL-recognized components under UL924 and UL1989. CSB is also certified by ISO 9001 and ISO 14001.

Dimensions

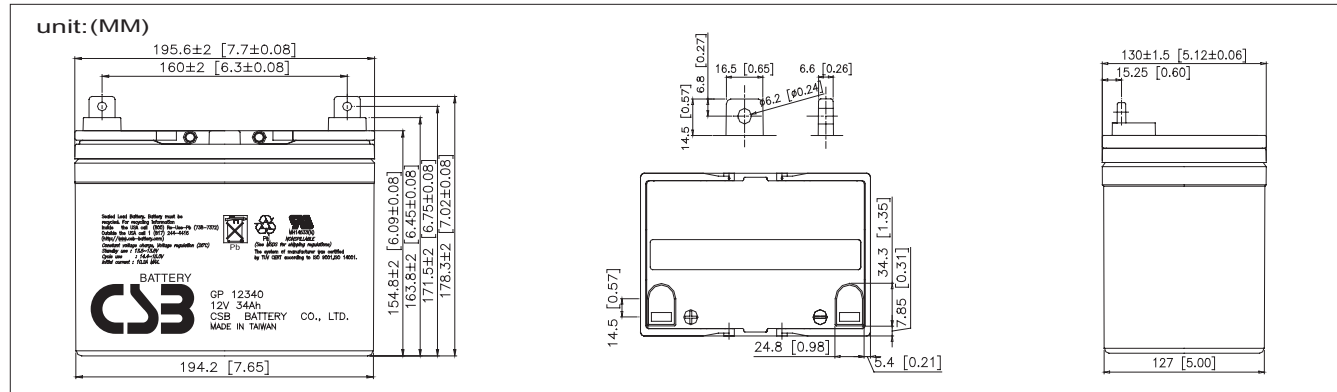

Constant Current Discharge Characteristics Unit:A (25°C, 77°F)

F.V/Time	5MIN	10MIN	15MIN	30MIN	1HR	2HR	3HR	4HR	5HR	8HR	10HR	20HR
1.60V	144	91.7	69.3	42.1	25.0	14.5	10.3	8.00	6.55	4.26	3.48	1.80
1.67V	128	85.5	66.2	41.4	24.9	14.4	10.3	7.99	6.51	4.24	3.43	1.72
1.70V	121	82.8	64.8	41.2	24.8	14.4	10.3	7.98	6.49	4.23	3.41	1.69
1.75V	110	77.5	61.8	40.2	24.4	14.3	10.2	7.94	6.47	4.19	3.36	1.64
1.80V	98.0	72.3	58.8	39.2	24.0	14.2	10.1	7.89	6.45	4.14	3.30	1.58
1.85V	86.3	67.0	55.7	38.2	23.6	14.0	10.0	7.85	6.43	4.10	3.25	1.53

Constant Power Discharge Characteristics Unit:W (25°C, 77°F)

F.V/Time	5MIN	10MIN	15MIN	30MIN	1HR	2HR	3HR	4HR	5HR	8HR	10HR	20HR
1.60V	1732	1100	832	505	300	174	124	96.0	78.6	51.1	41.7	21.6
1.67V	1539	1026	794	497	299	173	123	95.8	78.1	50.8	41.1	20.7
1.70V	1456	994	778	494	298	173	123	95.7	77.9	50.7	40.9	20.3
1.75V	1316	931	742	482	293	172	122	95.2	77.7	50.2	40.3	19.6
1.80V	1176	867	705	470	288	170	121	94.7	77.4	49.6	39.6	18.9
1.85V	1036	804	669	458	283	169	120	94.2	77.2	49.1	39.0	18.2

● All mentioned values are average values.

Trickle (or Float) Service Life

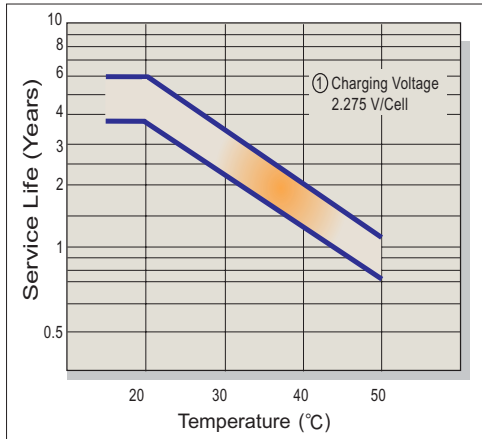

Capacity Retention Characteristic

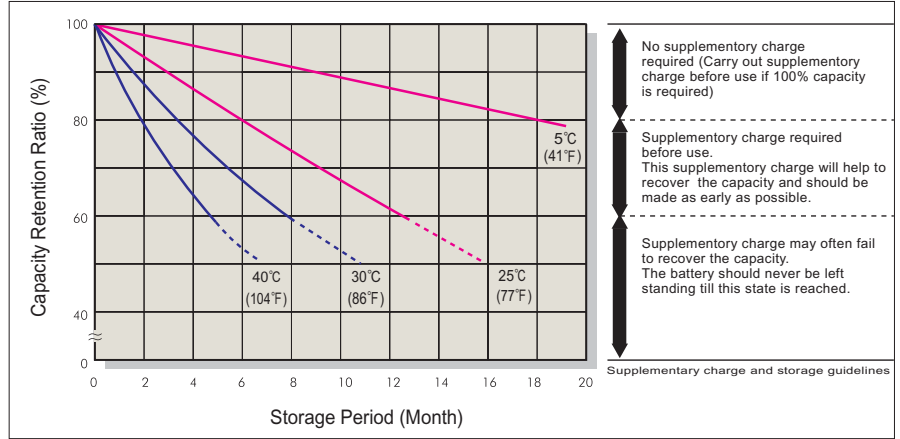

Battery Voltage and Charge Time for Standby Use

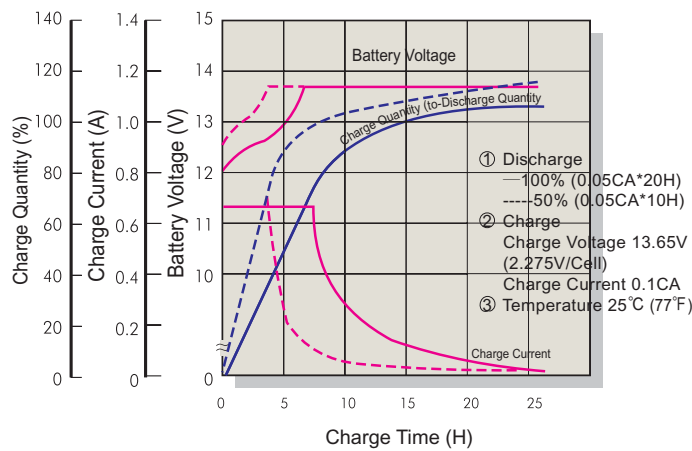

Cycle Service Life

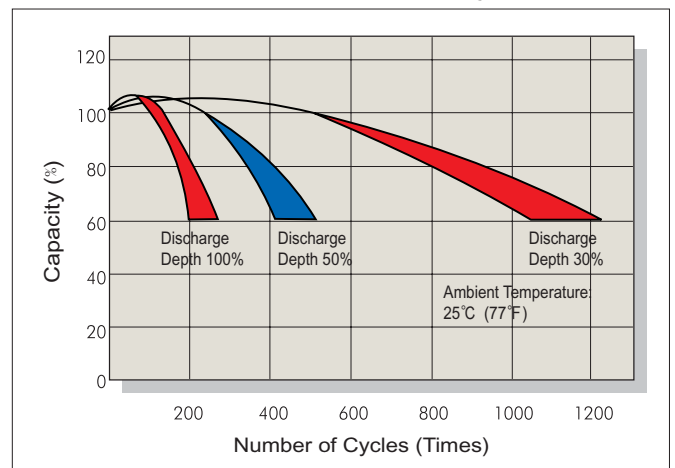

Battery Voltage and Charge Time for Cycle Use

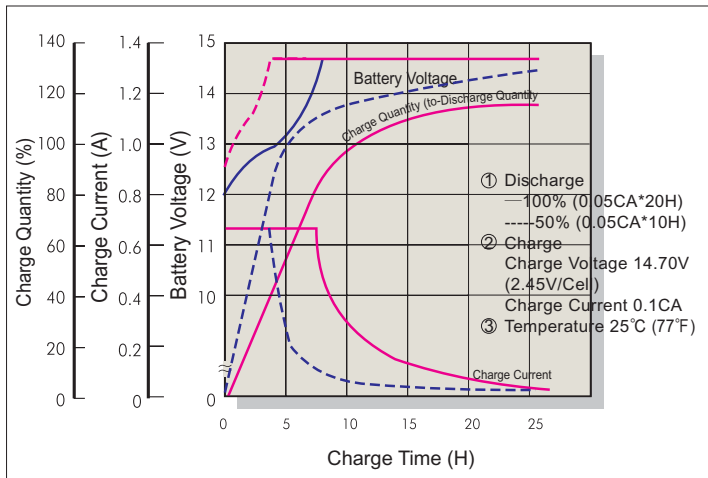

Terminal Voltage (V) and Discharge Time (25°C 77°F)

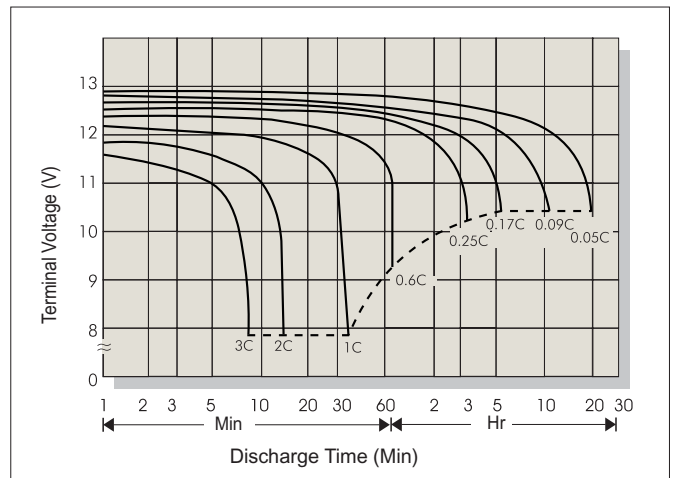

Charging Procedures

Application	Charge Voltage (V/Cell)			Max. Charge Current
	Temperature	Set Point	Allowable Range	
Cycle Use	25°C (77°F)	2.45	2.40-2.50	0.3C
Standby	25°C (77°F)	2.275	2.25-2.30	

Discharge Current VS. Discharge Voltage

Final Discharge Voltage V/Cell	1.75	1.70	1.55	1.30
Discharge Current (A)	0.2C>(A)	0.2C<(A)<0.5C	0.5C<(A)<1.0C	(A)>1.0C